

## SUCTION HATCH FOR SUCTION ANCHOR INSTALLATION / RETRIEVAL

SubseaDesign suction hatches are highly efficient during the subsea operation. It is supplied prepared for welding into suction anchor top and can be delivered with pipe outlet to interface with a suction system.

It can also be delivered with integrated suction stab receptacle.

### FEATURES AND BENEFITS

- ✓ ROV friendly operation
- ✓ Integrated locking mechanism
- ✓ Sealing arrangement accepts both suction and overpressure
- ✓ Compact design

### INTERFACES

- ✓ Prepared for welding into suction anchor top
- ✓ Can be delivered with pipe outlet to interface with suction system
- ✓ Can be delivered with integrated suction stab receptacle
- ✓ Can be delivered with anodes to protect hatch for the service life
- ✓ Delivered with electrical strapping

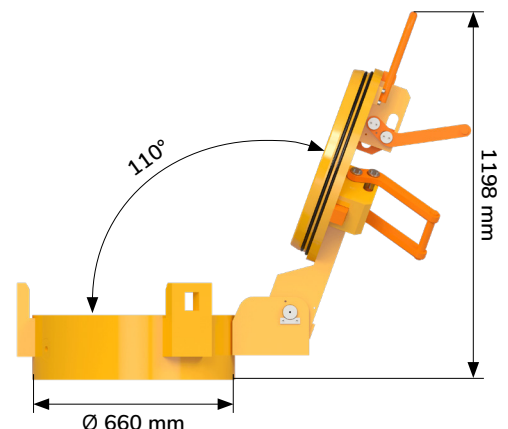
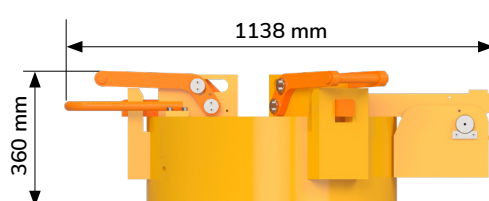
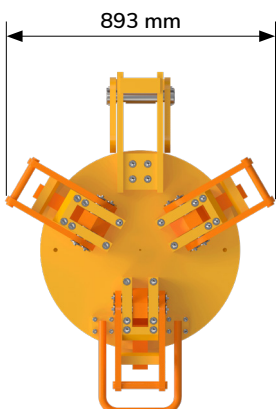

# SUCTION HATCH

## 660 MM, 20 BAR, SD004-RXF-1502



Template during installation with SubseaDesign delivered suction hatches

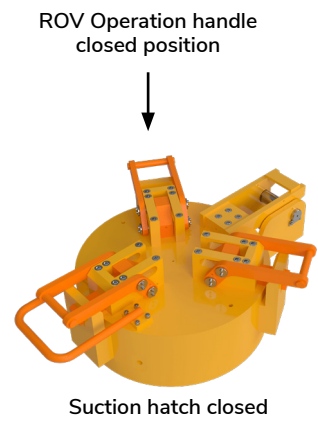
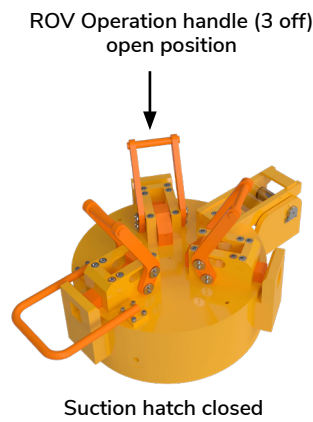
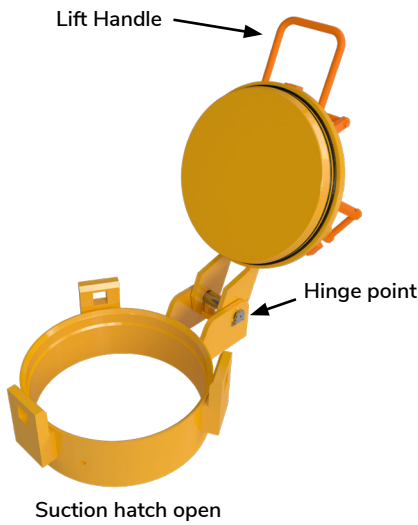
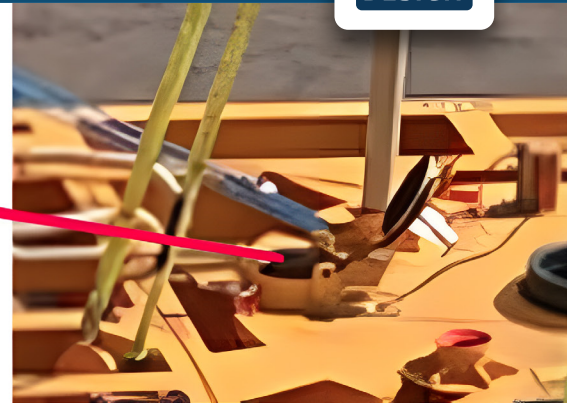

### HOW IT WORKS

During installation, the hatch is secured in opened position. After suction anchor landing and self-penetration, the ROV will remove the securing mechanism. The hatch then closes by freefalling. The ROV will operate the handles to closed position.

During suction anchor retrieval the suction hatch will be opened when the suction anchor is ready to be lifted out of the ground. The operation handles will be released, and the hatch is rotated with the assistance of a lift wire to surface.

### TECHNICAL DATA

Design code	ISO 13628
Pipe size	660 mm diameter
Height (open)	360 (1198) mm
Width	893 mm
Length	1138 mm
Weight	453 Kg
Pressure rating	20 bar
Max. water depth	No limitation
Coating	Typical Norsok system 7, or as required

visit product page

