

TECHNICAL DATA

Design code	ISO 13628-8
Size pipe	168.3 mm diameter
Height	194 mm
Width	270 mm
Length	194 mm
Weight	12.2 kg
Coating	Xylan

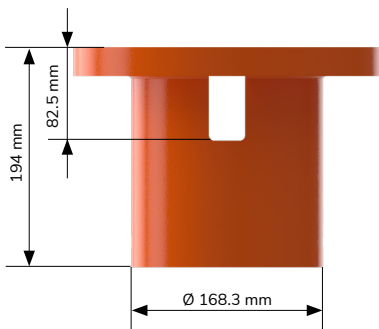

FRONT VIEW

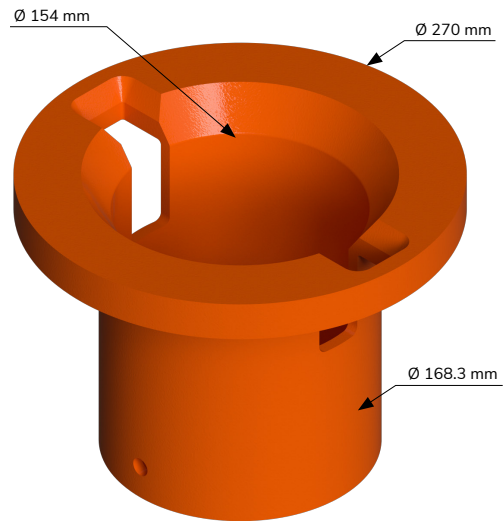
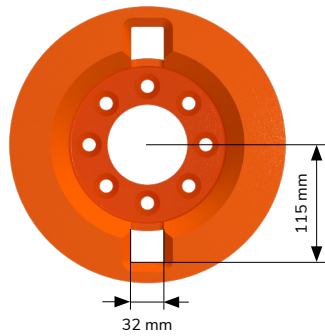

TOP VIEW

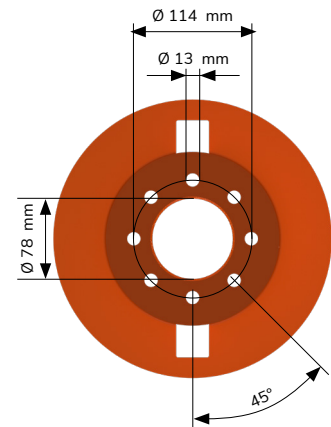

BOTTOM VIEW

visit product page

